

Oportunidades para a Cadeia de Fornecedores do Setor de Petróleo e Gás

Campinas, 18 de Junho de 2010



Ministério de
Minas e Energia



ABCE - ABDIB - ABEMI - ABIMAQ - ABINEE - ABITAM - BNDES - CNI - IBP - ONIP - SINAVAL

Objetivo do PROMINP



“Maximizar a participação da **indústria nacional** de bens e serviços, em bases **competitivas e sustentáveis**, na implantação de projetos de óleo e gás no Brasil e no exterior.”

Gestão do PROMINP

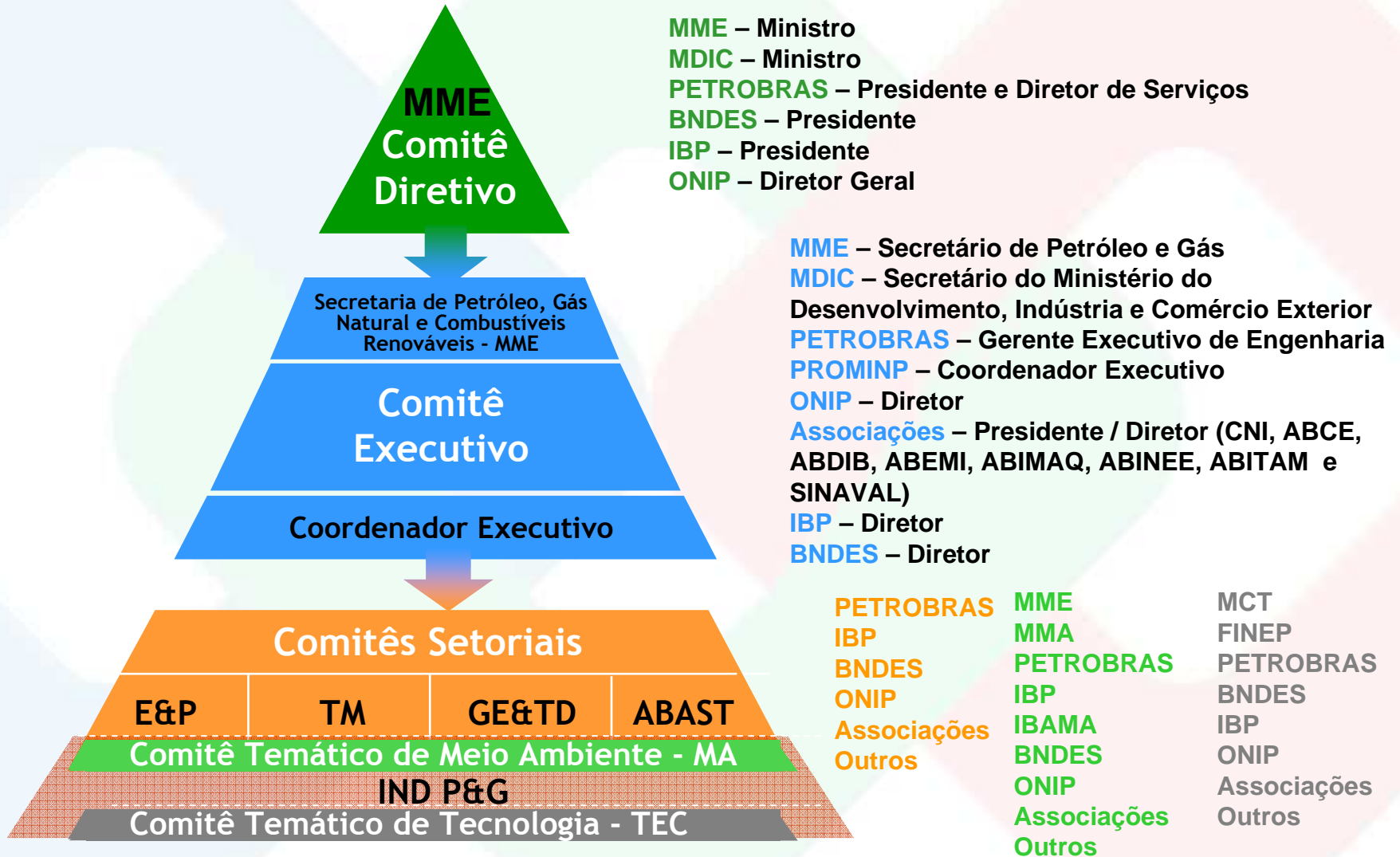

Estruturação do Programa



DESAFIO
Maximizar
Conteúdo
Local

Temas estratégicos

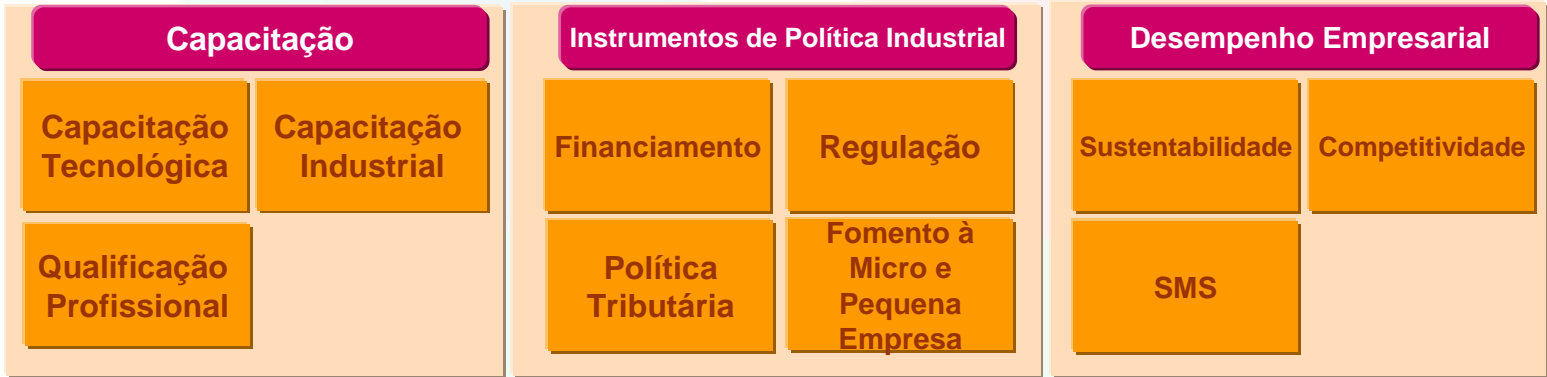

Carteira de Projetos do Prominp

- E&P
- TM
- ABAST
- GE&TD
- IND P&G
- MA
- TEC

Evolução dos Investimentos da Petrobras no Brasil

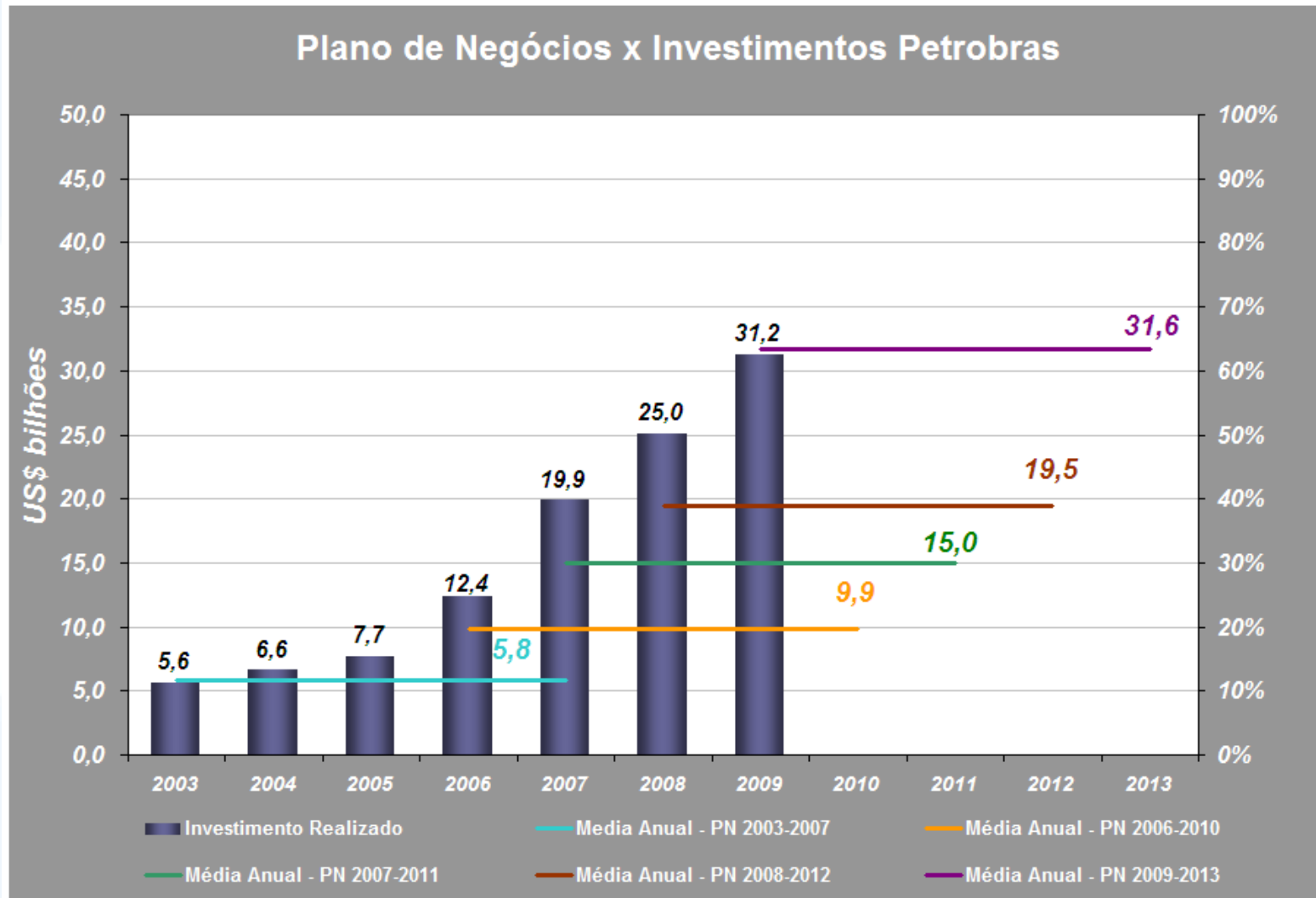

Fonte: Petrobras

Diagnóstico da Indústria Nacional

Exploração & Produção

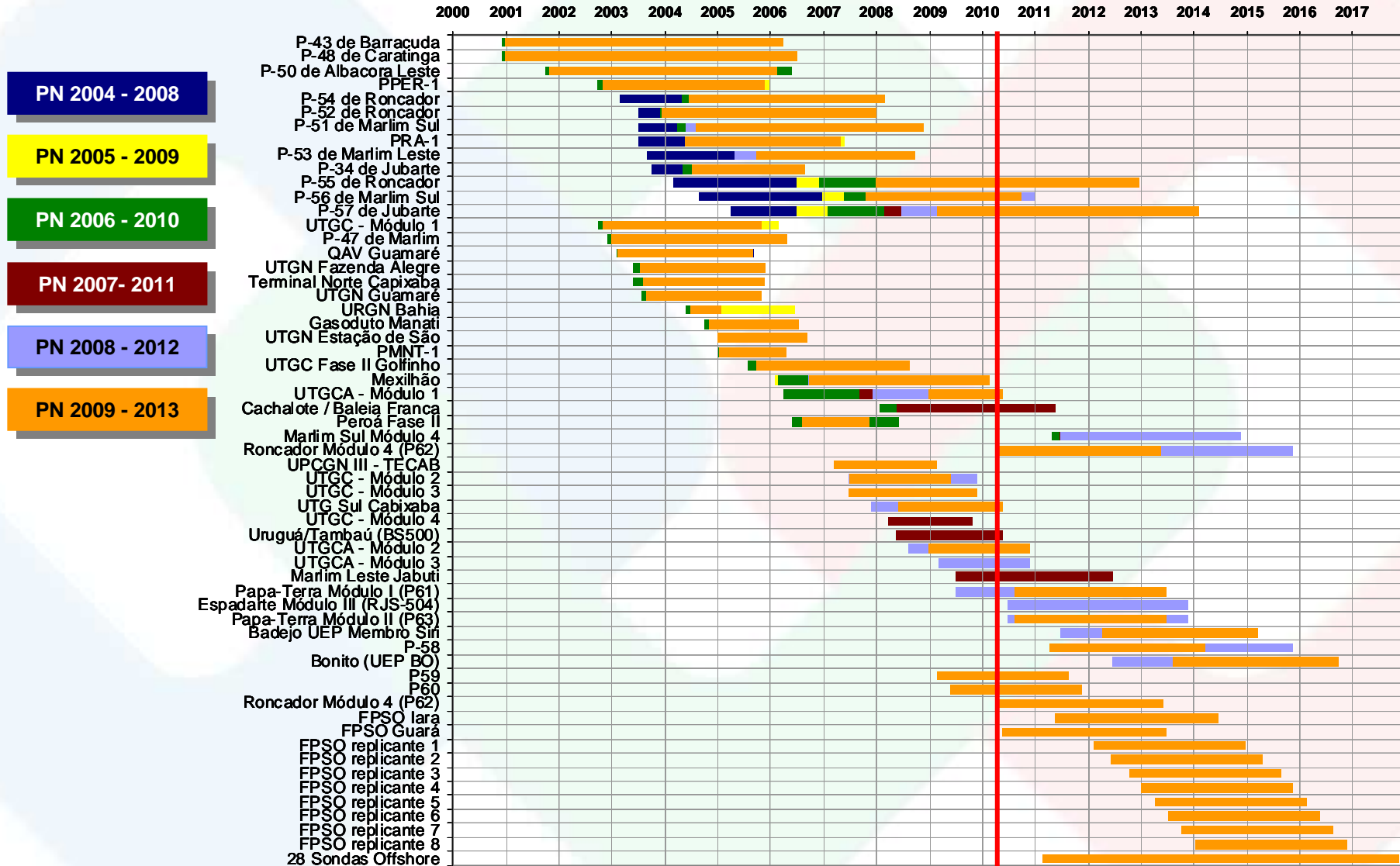

Diagnóstico da Indústria Nacional

Abastecimento



2000 2001 2002 2003 2004 2005 2006 2007 2008 2009 2010 2011 2012 2013 2014 2015 2016 2017

PN 2004- 2008

PN 2005 - 2009

PN 2006 - 2010

PN 2007- 2011

PN 2008 - 2012

PN 2009 - 2013

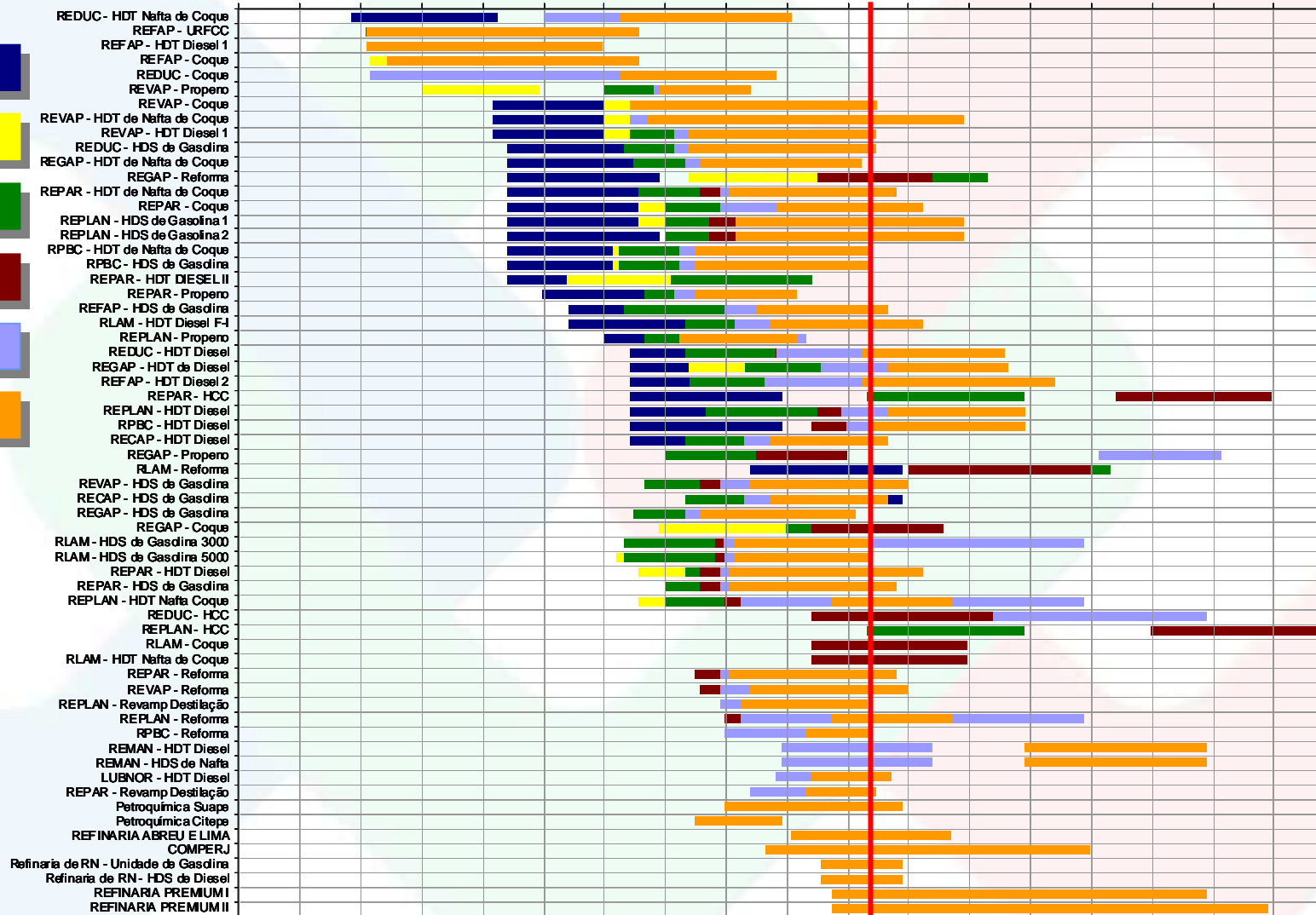

Diagnóstico da Indústria Nacional

Gás, Energia & Transporte Dutoviário

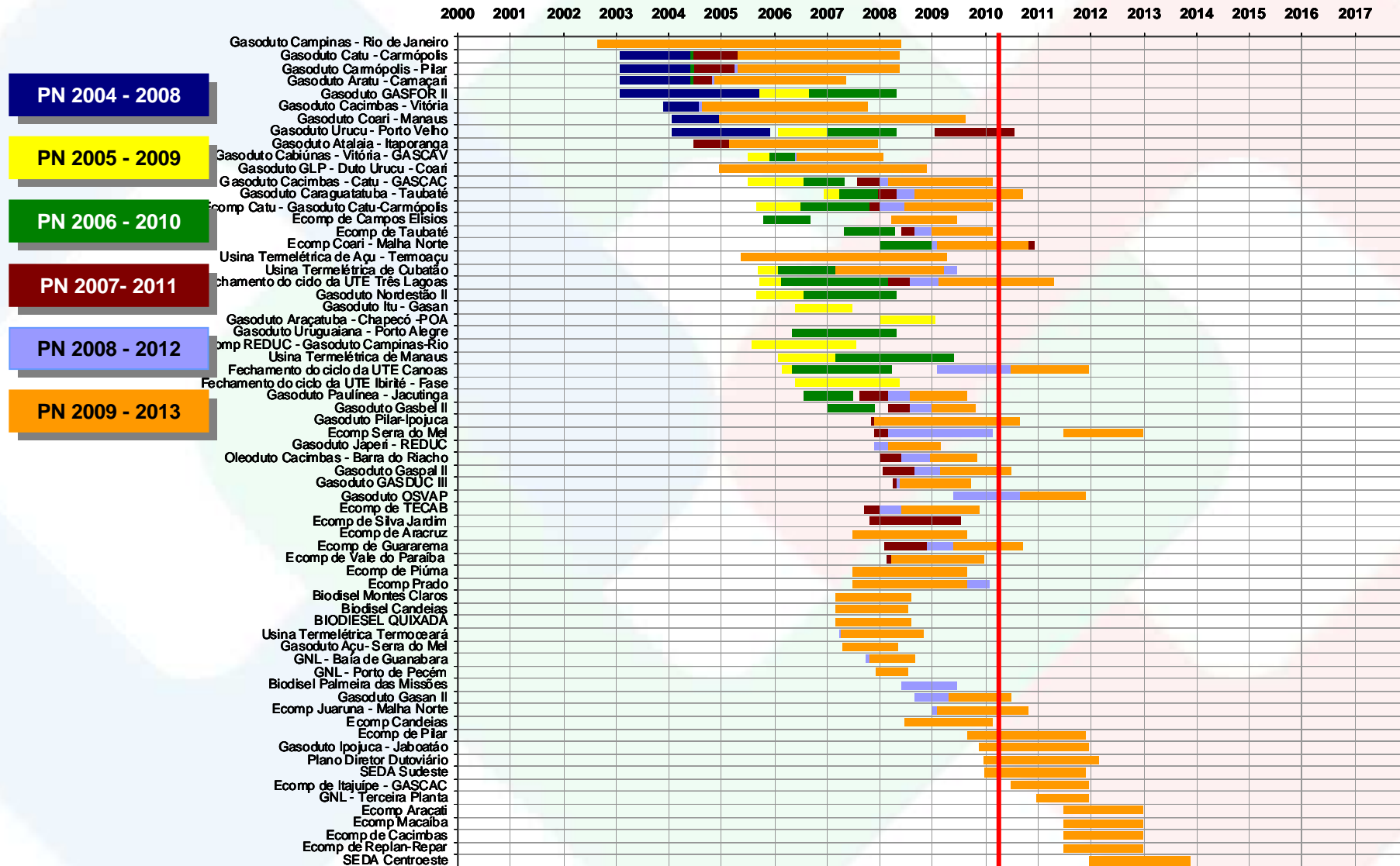

Diagnóstico da Indústria Nacional

Transporte Marítimo



- PN 2004 - 2008
- PN 2005 - 2009
- PN 2006 - 2010
- PN 2007- 2011
- PN 2008 - 2012
- PN 2009 - 2013

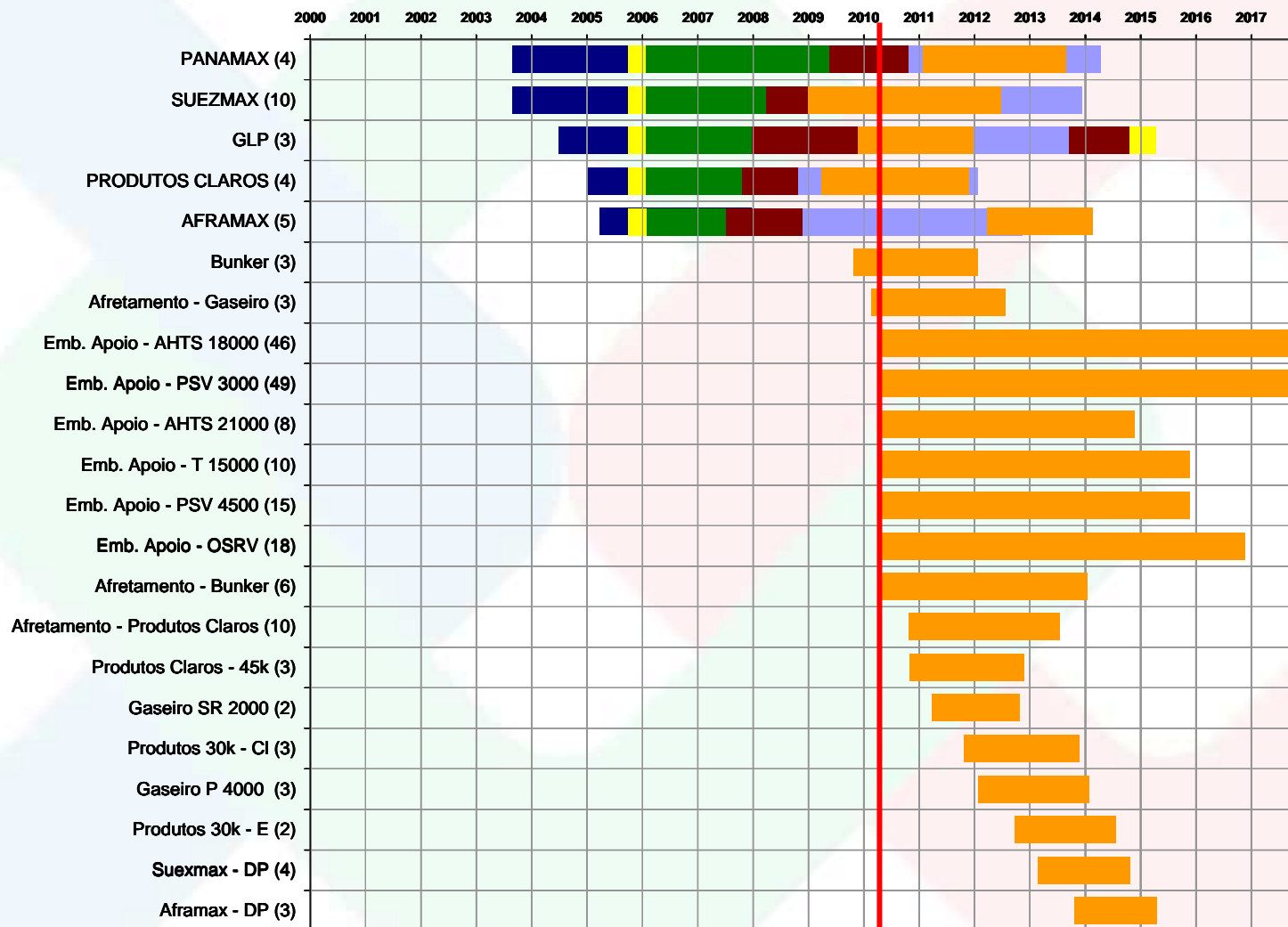

Diagnóstico da Indústria Nacional



CARTEIRA DE INVESTIMENTOS (Conjunto de projetos)

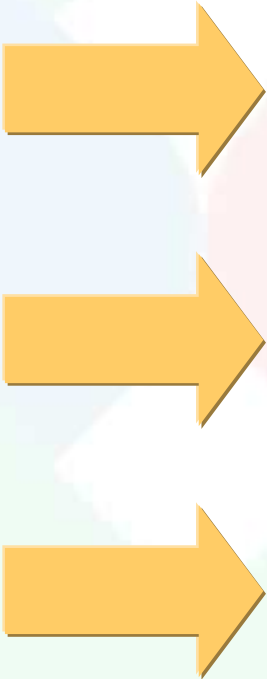
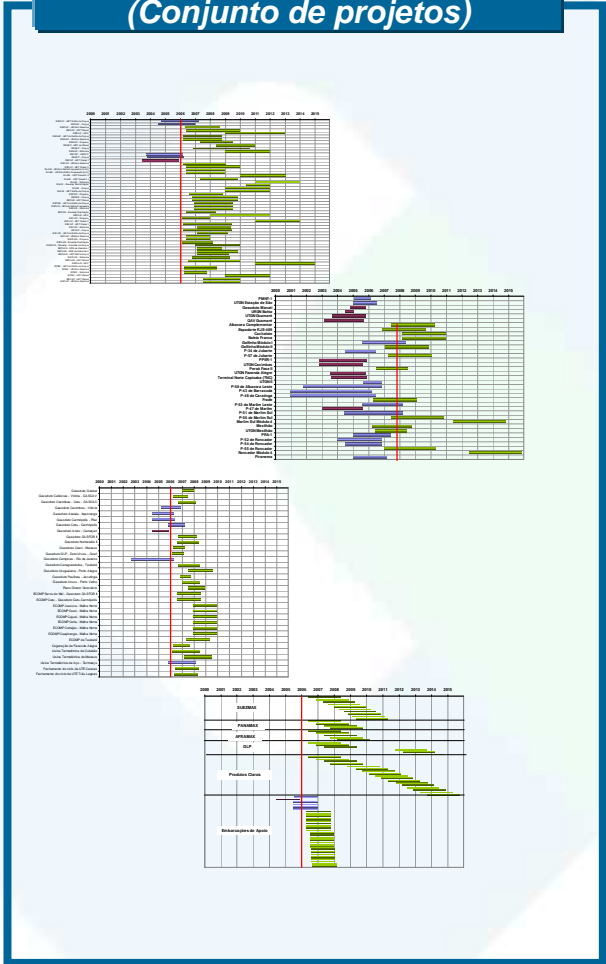

DEMANDA POR RECURSOS

Recursos críticos
PESSOAS

Recursos críticos
MATERIAIS & EQUIPAMENTOS

Recursos críticos
INFRA-ESTRUTURA DE PRODUÇÃO

Qualificação Profissional

Conceitos



DIAGNÓSTICO

IMPLEMENTAÇÃO

Carteira de Projetos

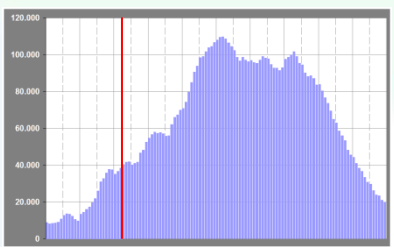
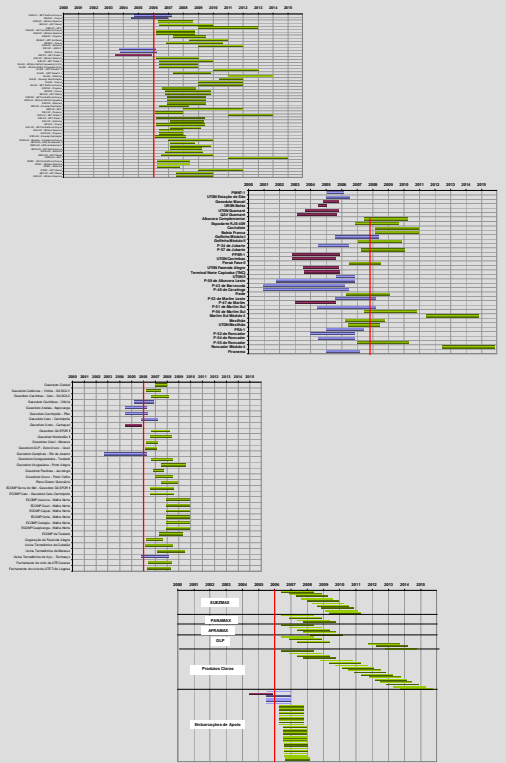

Categorias Profissionais

Regionalização da Demanda



Demanda Regional

Demanda RJ

Demanda SP

Demanda PE

Demanda ES

Demanda XX

COMITÊ DE GESTÃO DO PNQP

Plano de Negócios 2008-2012

Demandas de Recursos Humanos

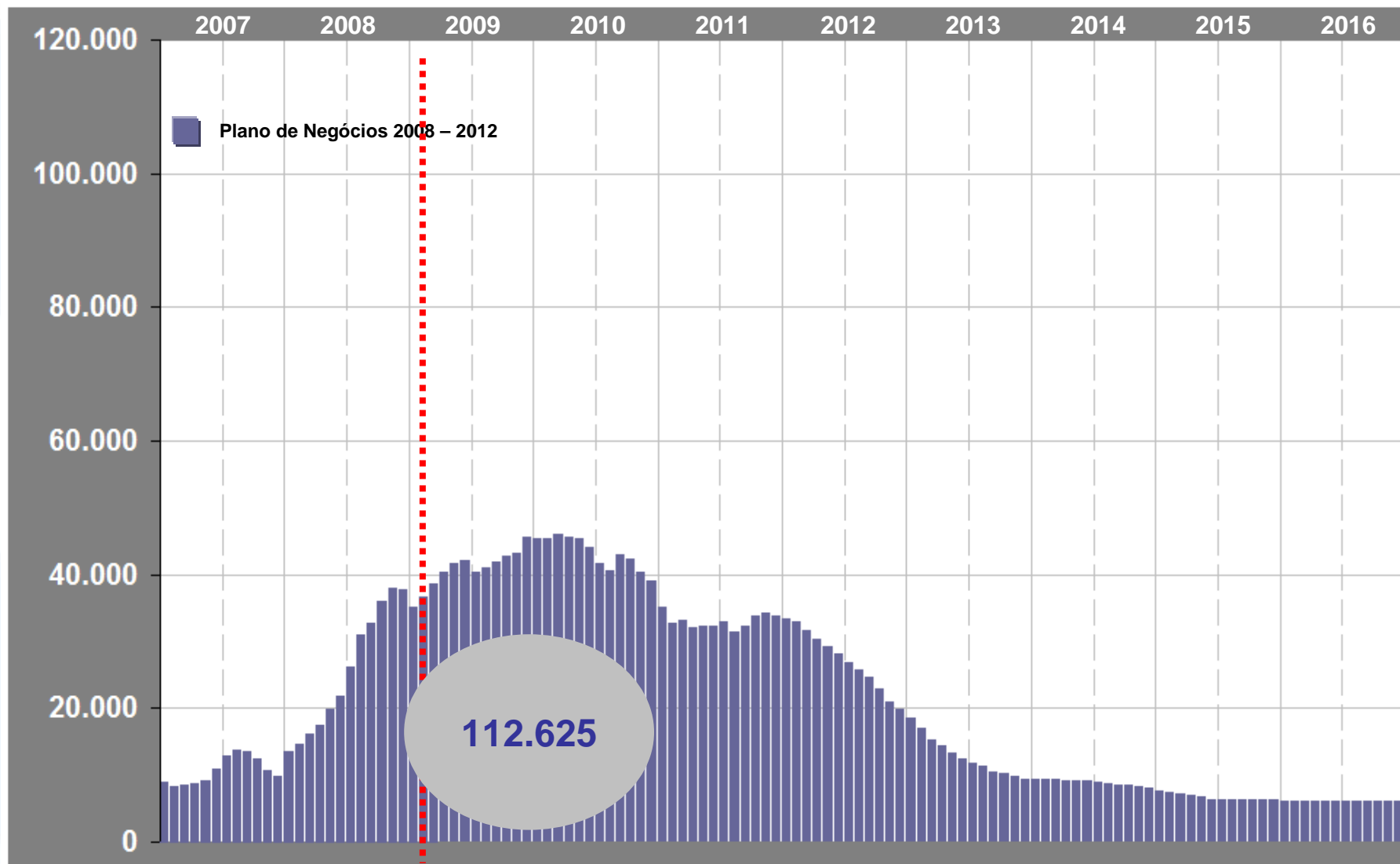

Plano de Negócios 2008-2012

Demandas de Recursos Humanos

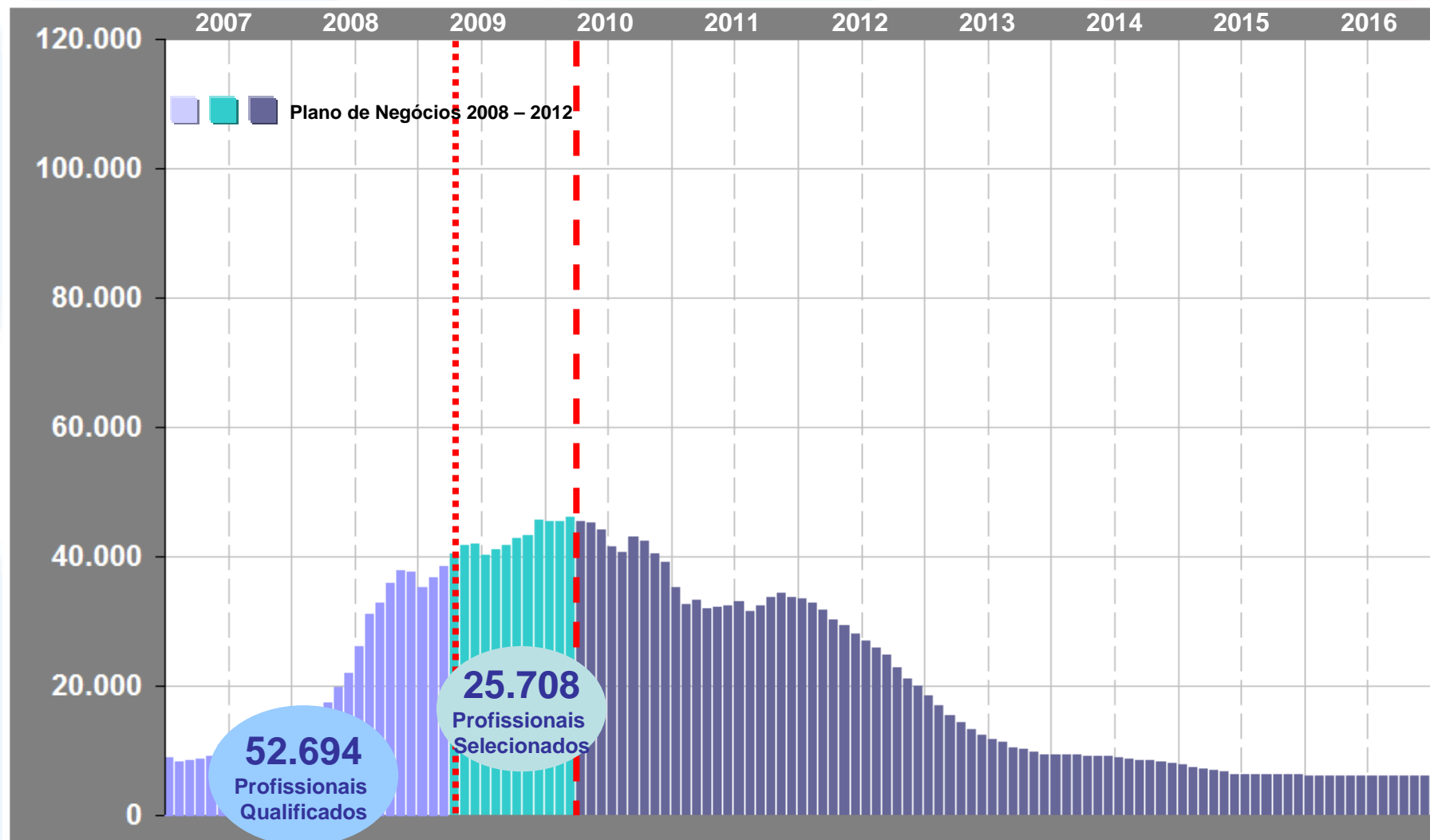

Plano de Negócios 2009-2013

Demandas de Recursos Humanos

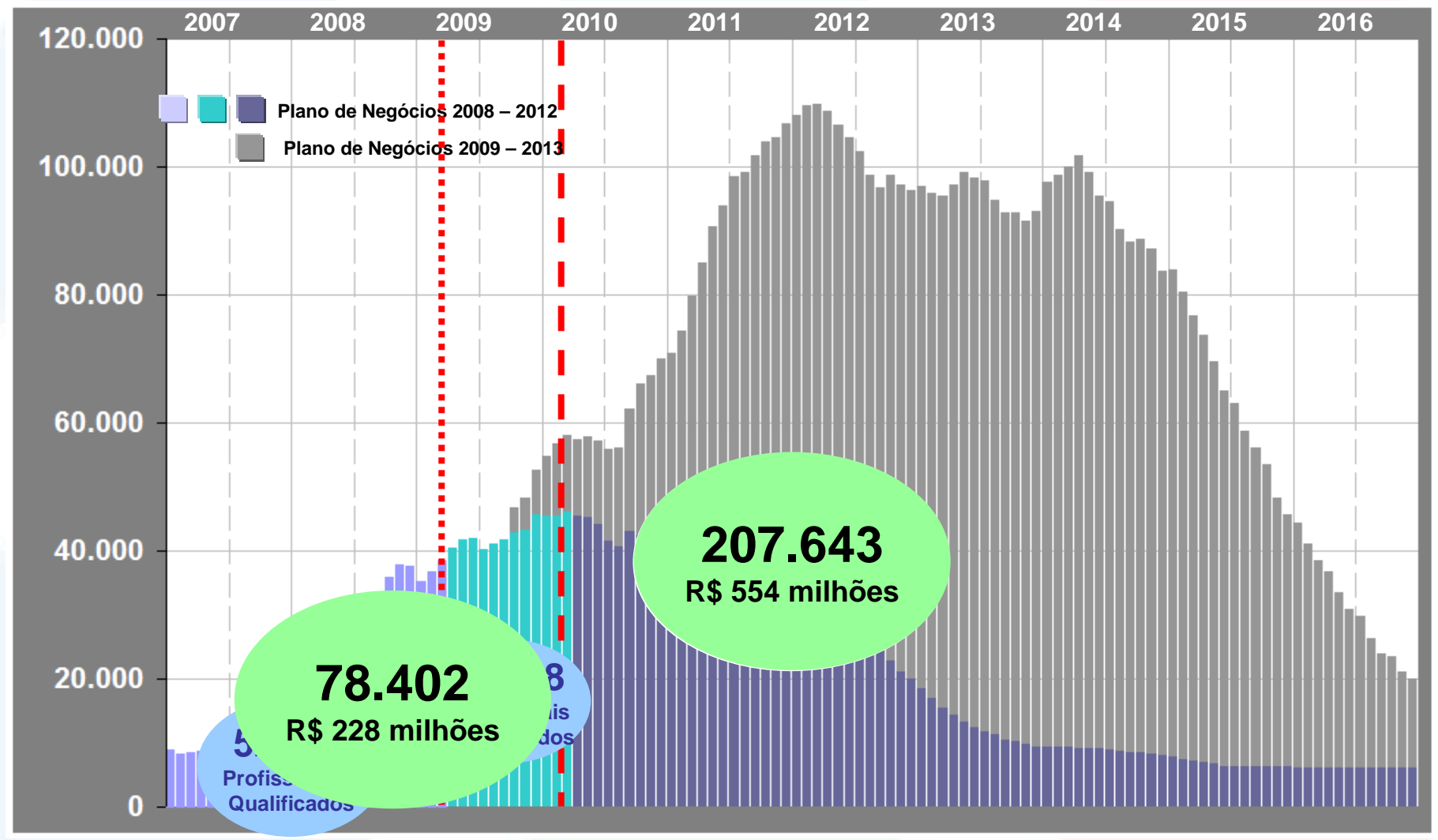

Plano de Negócios 2009-2013

Demandas de Recursos Humanos

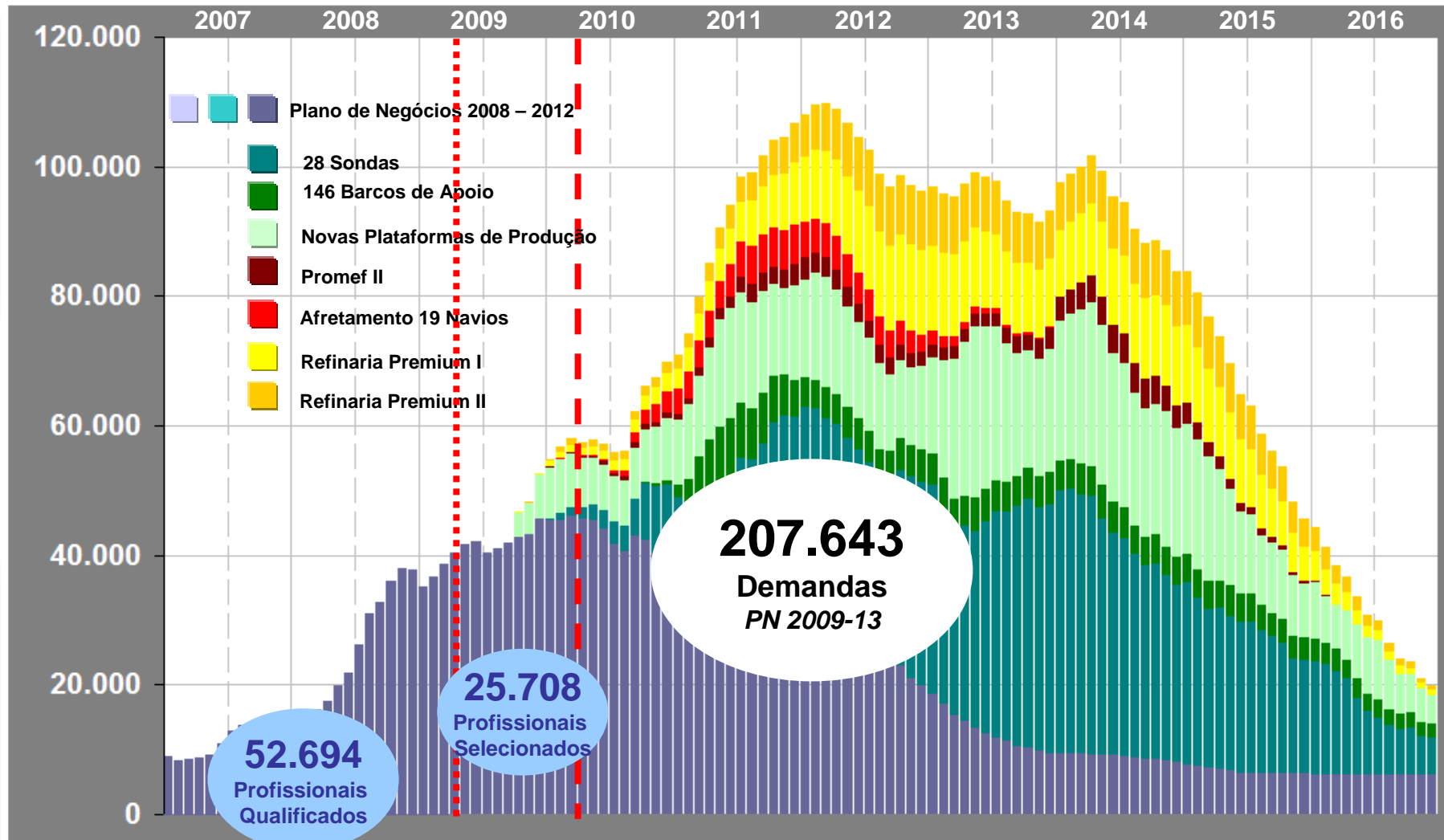

Qualificação Profissional

Necessidade de Capacitação



ESTADO	CURSOS	TURMAS	QUANTIDADE
AM	19	90	1.473
BA	36	297	4.905
CE	31	908	16.125
ES	36	200	3.292
MA	29	1.276	22.692
MG	23	82	1.448
PE	29	982	15.931
PR	28	252	4.380
RJ	138	2.428	43.764
RN	43	314	5.284
RS	40	265	4.434
SC	13	85	1.416
SP	165	1.110	19.756
Não Definido	66	3.622	62.743
TOTAL GERAL	696	11.911	207.643

Diagnóstico da Indústria Nacional



CARTEIRA DE INVESTIMENTOS (Conjunto de projetos)

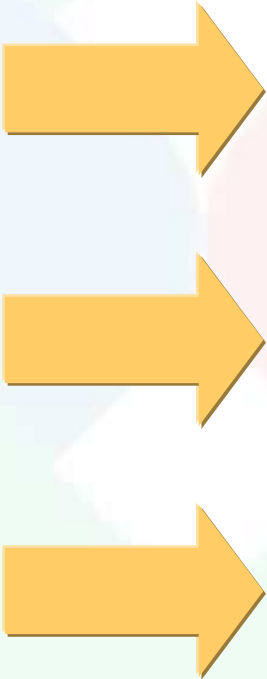
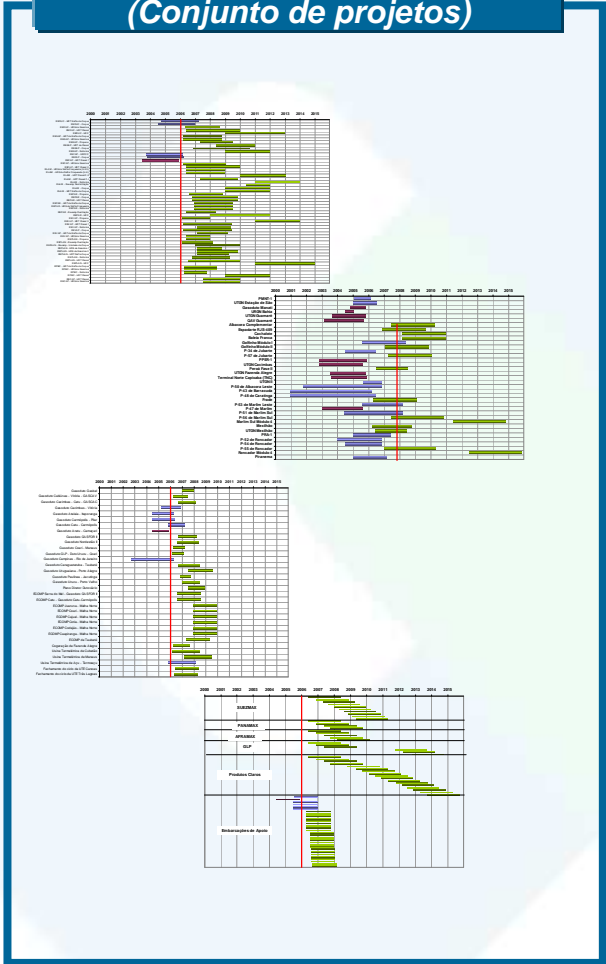

DEMANDA POR RECURSOS

Recursos críticos
PESSOAS

Recursos críticos
MATERIAIS & EQUIPAMENTOS

Recursos críticos
INFRA-ESTRUTURA DE PRODUÇÃO

Demandas de Materiais & Equipamentos



DIAGNÓSTICO

CARTEIRA DE INVESTIMENTOS (Conjunto de projetos)

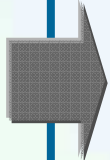
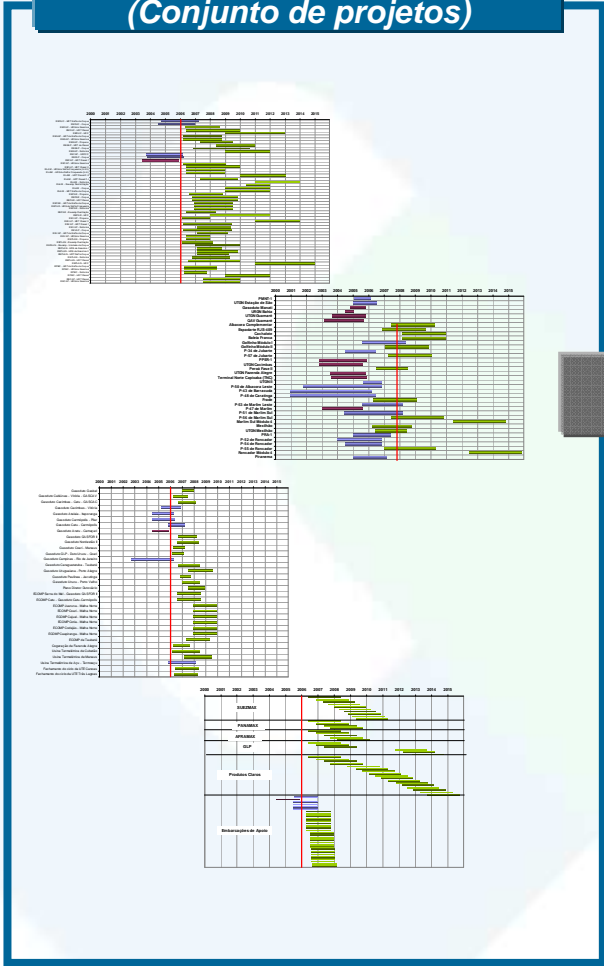

Famílias de Equipamentos

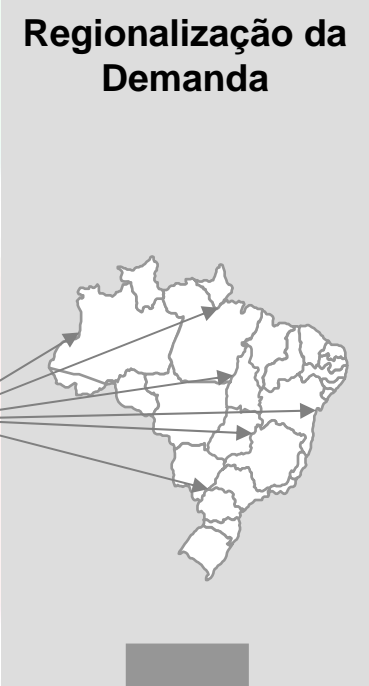

Total Brasil



Decomposição da Demanda e Cadeia de Suprimento



Cadeia de Suprimento de B&S

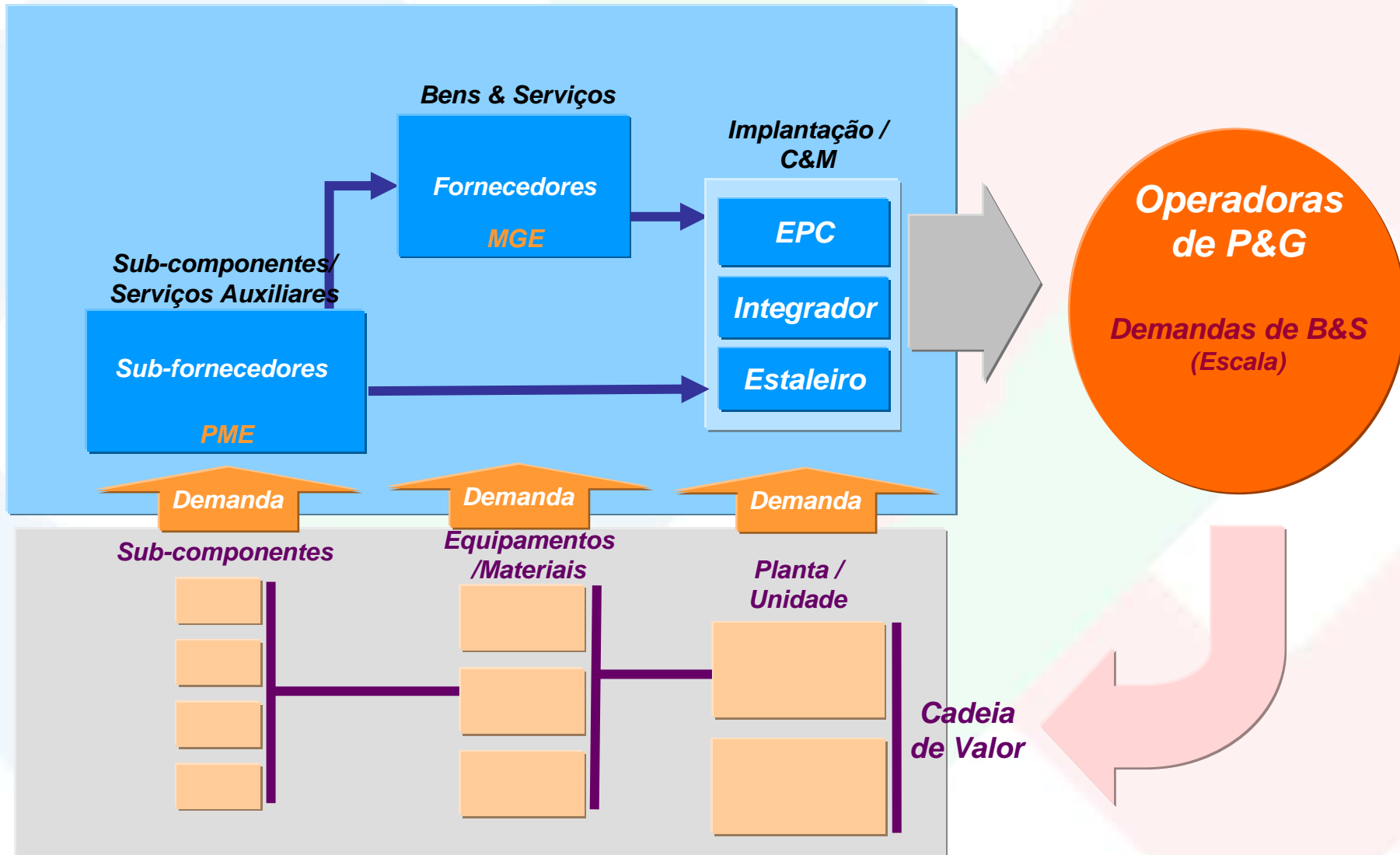

Demandas de Equipamentos



Demanda anual por família

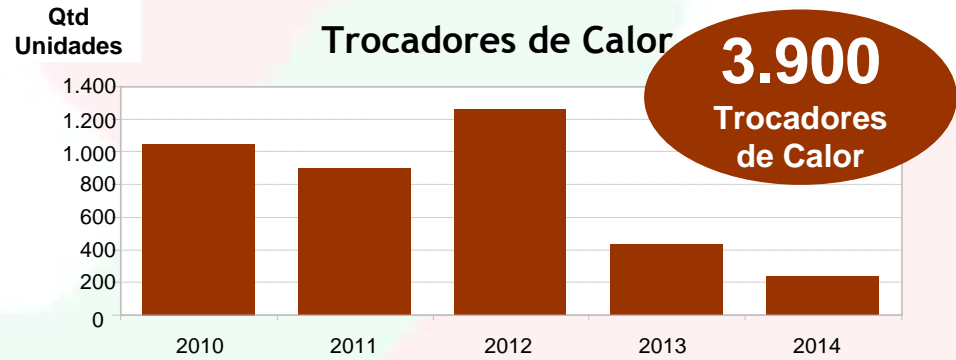
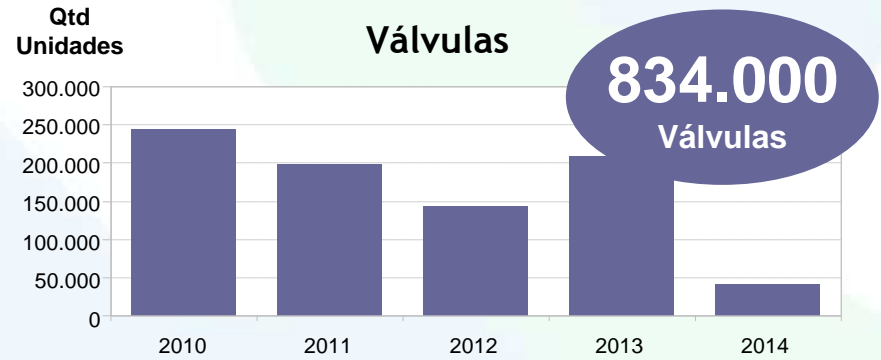
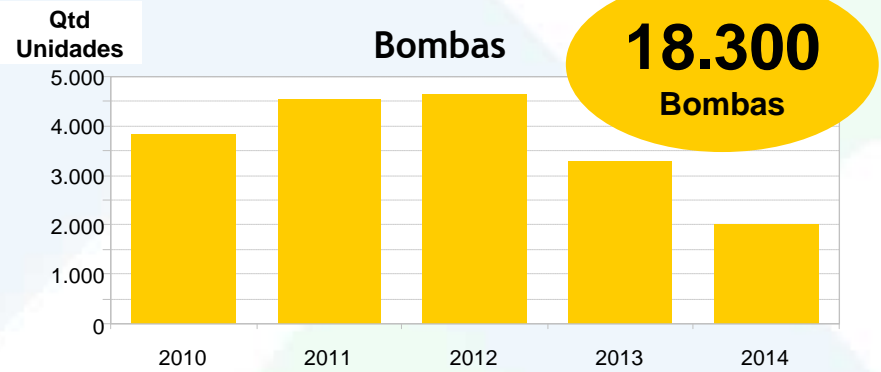

Demandas de Equipamentos



Demanda trimestral por família

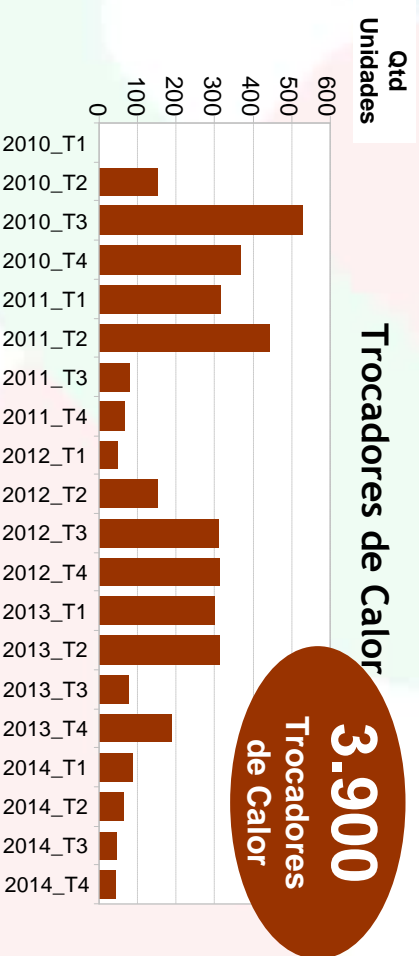
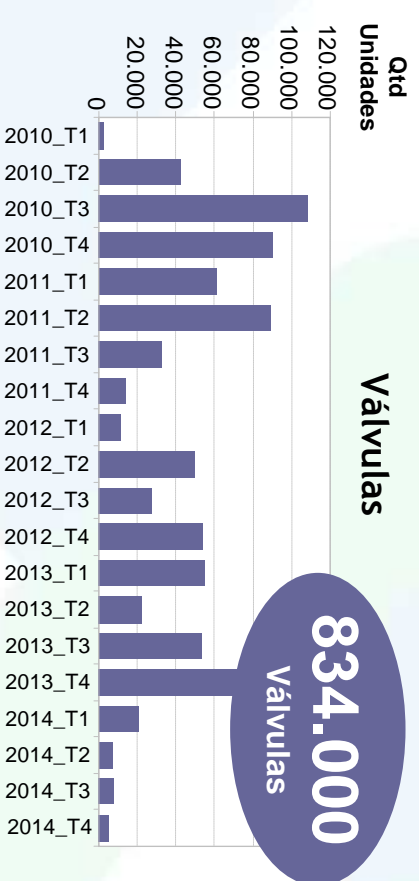
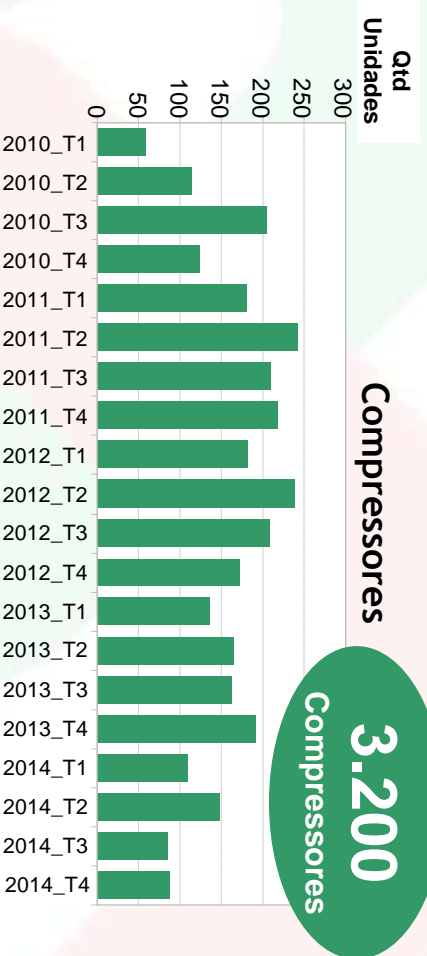
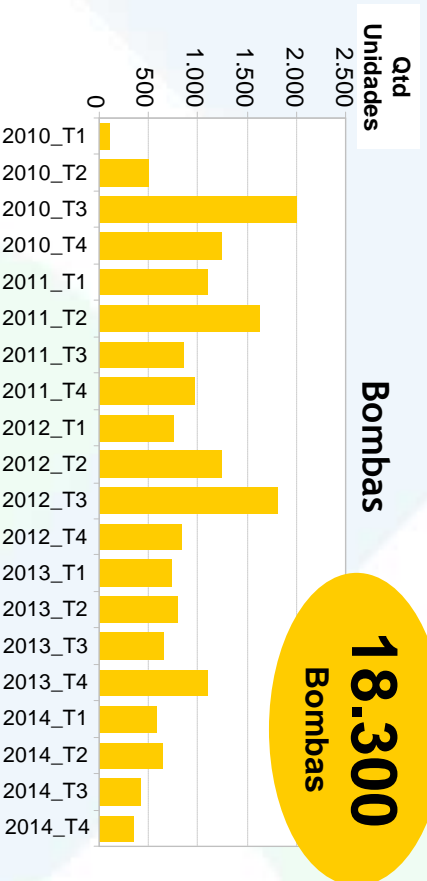

Demandas de Equipamentos



Demanda trimestral por família e por sub-família

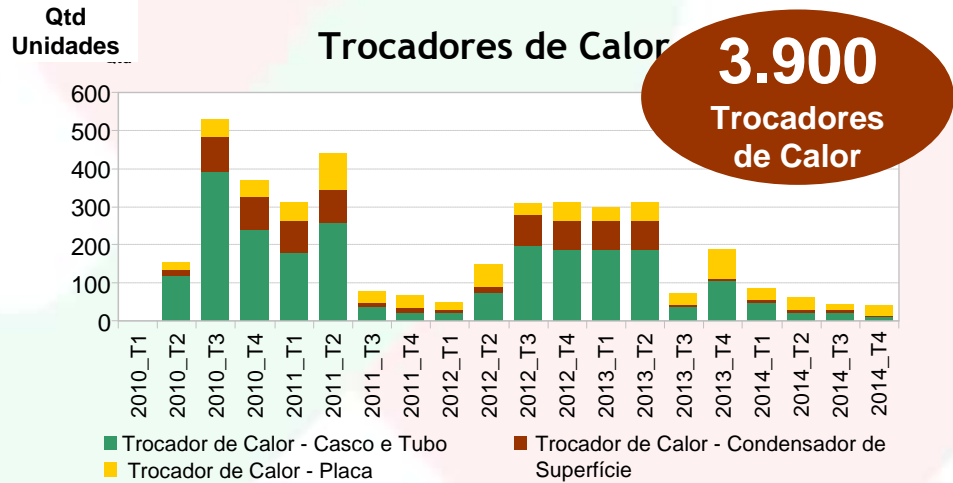
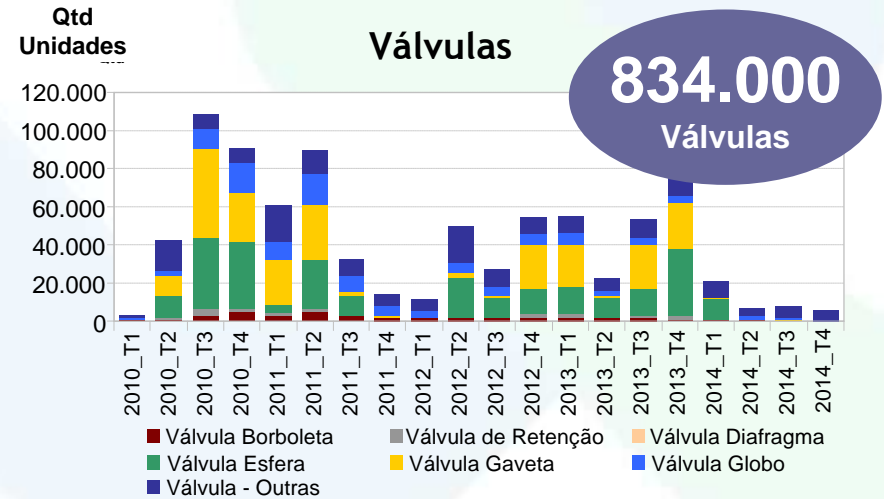
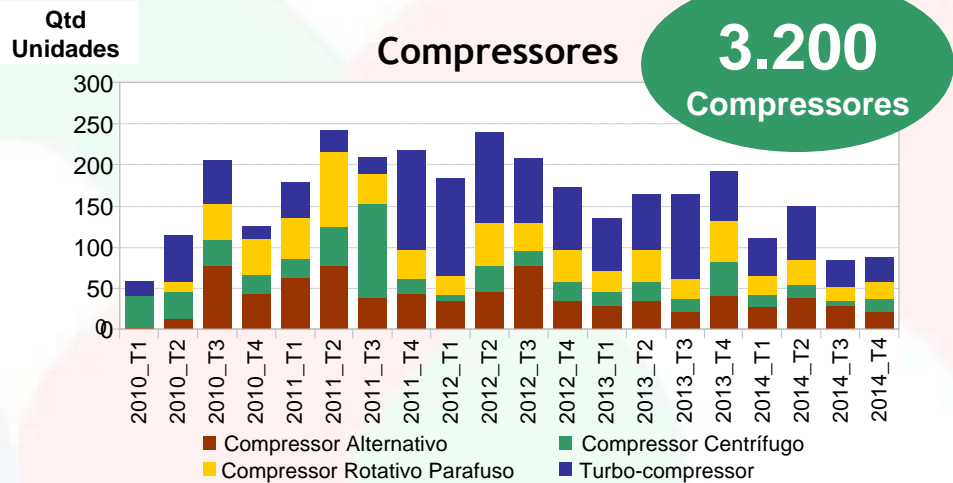
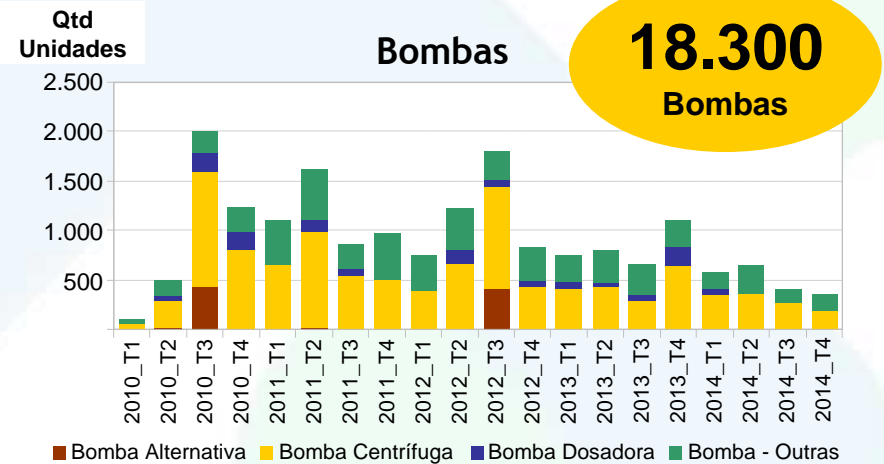

Demandas de Equipamentos



Demanda trimestral por equipamento

Válvula Gaveta

**Qty
Unidades**

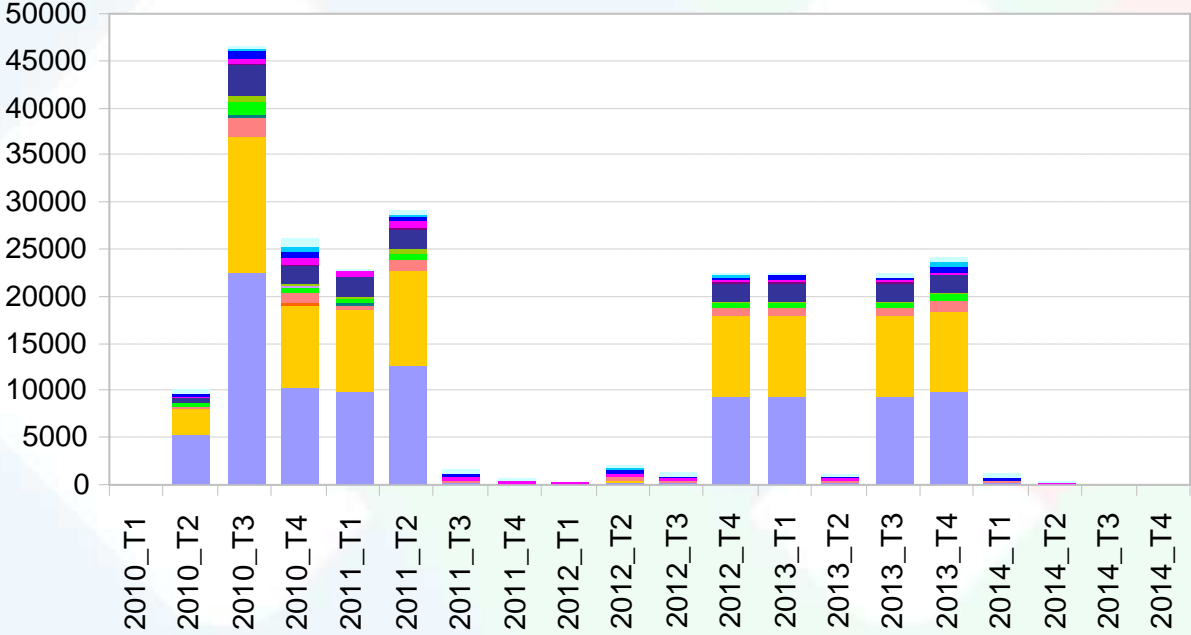

- Válvula Gaveta_Aço Carbono_Forjado_DN Até 1 1/2"
- Válvula Gaveta_Aço Carbono_Forjado_DN = 2" Até 12"
- Válvula Gaveta_Aço Carbono_Fundido_DN Até 12"
- Válvula Gaveta_Aço Carbono_Fundido_DN = 14" até 24"
- Válvula Gaveta_Aço Carbono_Fundido_DN > 24"
- Válvula Gaveta_Aço Inox_Forjado_DN Até 1 1/2"
- Válvula Gaveta_Aço Inox_Fundido_DN Até 1 1/2"
- Válvula Gaveta_Aço Inox_Fundido_DN = 2" Até 12"
- Válvula Gaveta_Aço Inox_Fundido_DN = 14"
- Válvula Gaveta_Aço Liga_Forjado_DN Até 1 1/2"
- Válvula Gaveta_Aço Liga_Forjado_DN = 2" Até 12"
- Válvula Gaveta_Bronze_Fundido_DN Até 1 1/2"
- Válvula Gaveta_Bronze_Fundido_DN = 2" Até 12"
- Válvula Gaveta_Ferro Fundido_Fundido_DN = 2" Até 12"
- Válvula Gaveta_Ferro Fundido_Fundido_DN = 14"
- Válvula Gaveta_Ni/Br/Al_Fundido_DN Até 1 1/2"
- Válvula Gaveta_Ni/Br/Al_Fundido_DN = 2" Até 12"
- Válvula Gaveta_Indefinido_Indefinido_Indefinido
- Válvula Gaveta_Aço Inox_Forjado_DN = 14"

Levantamento de Componentes

Exemplo de Válvulas

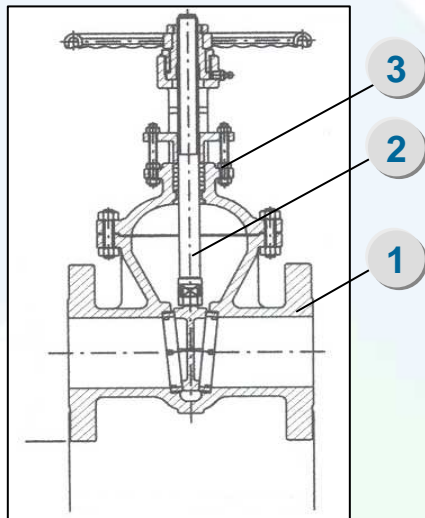

Exemplo de Válvula Gaveta

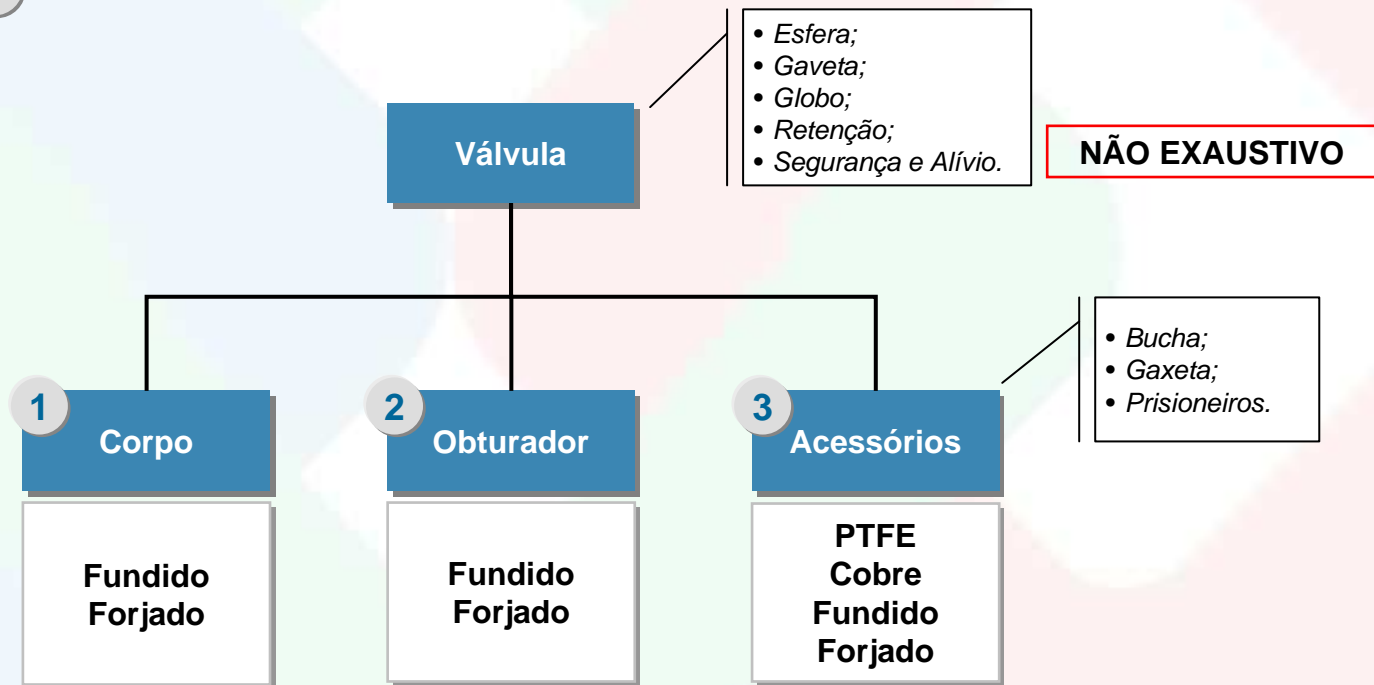

Levantamento de Componentes

Exemplo de Trocadores de Calor

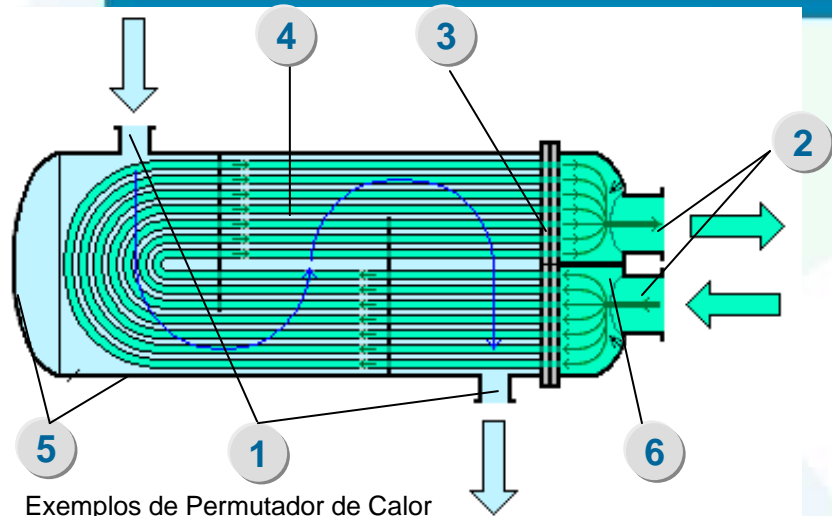

Exemplos de Permutador de Calor

Permutador de Calor

NÃO EXAUSTIVO



Demandas de Componentes

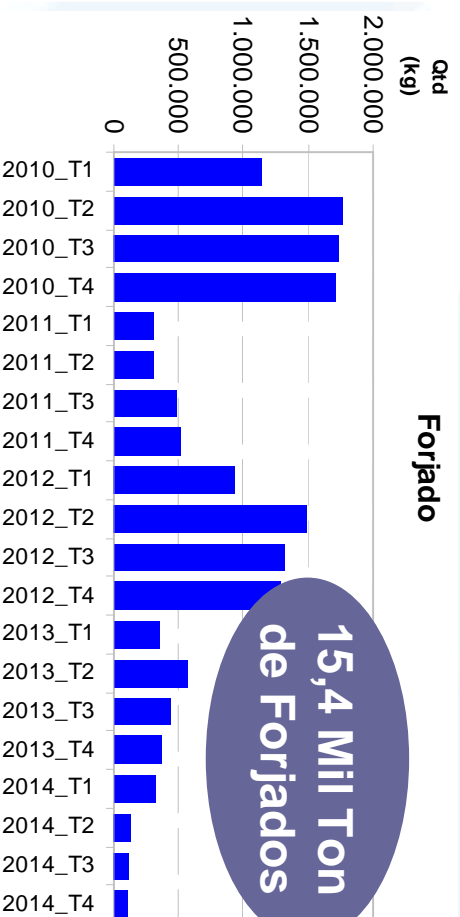
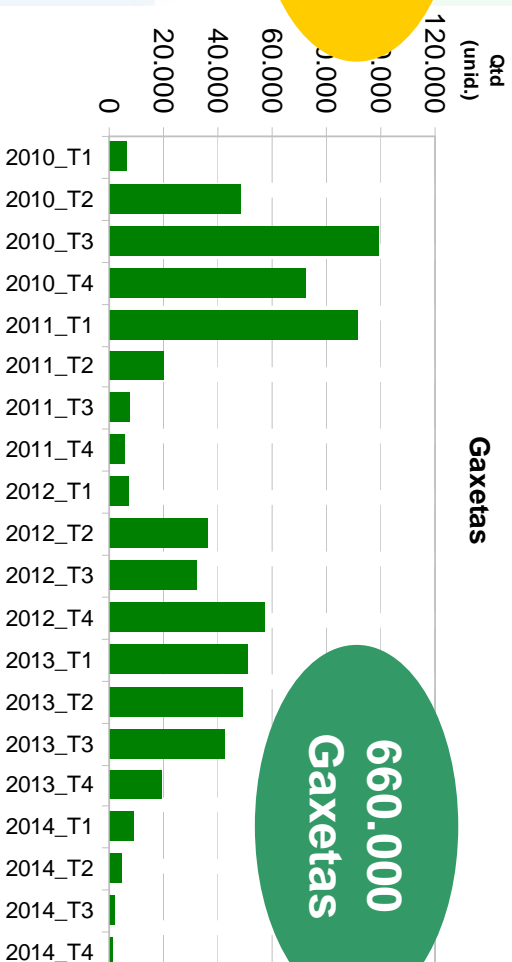
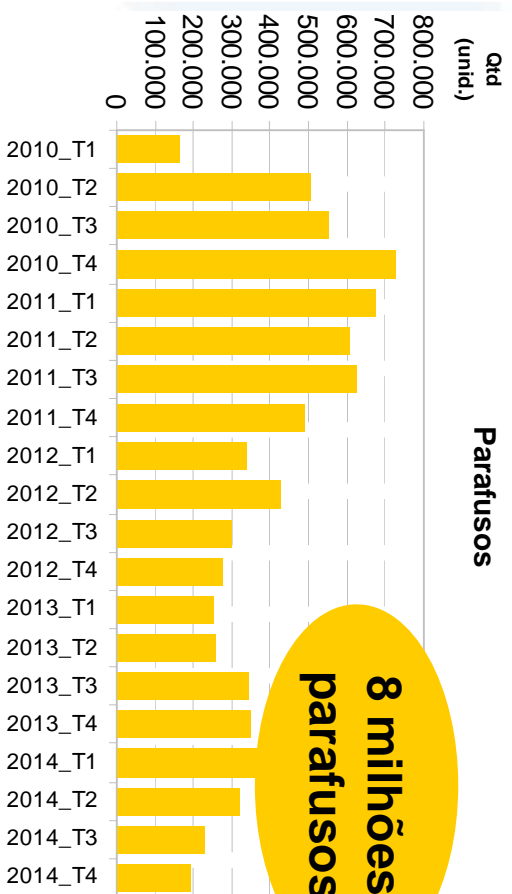

Portal de Oportunidades da Cadeia de Suprimentos do Setor de Petróleo de Gás Natural



v1.0.4

Programa de Mobilização da Indústria Nacional de Petróleo e Gás Natural



Portal de Oportunidades da Cadeia de Suprimentos do Setor de P&G

[Página Inicial](#)

[Área para Fornecedores](#)

[Demandas de Materiais e Equipamentos](#)

› [Relatório Consolidado](#)

[Relatório Detalhado](#)

[Quem Vende o que eu Compro](#)

[Quem Compra o que eu Vendo](#)

[Prestadores de Serviços](#)

[Profissionais Qualificados](#)

[Buscar Produtos](#)

[Minha Área](#)

[Sair](#)



Veja e seja visto por empresas de todo o Brasil

Aqui você encontra os fornecedores e compradores de bens e serviços do setor de petróleo e gás natural de todo o País, além de informações sobre as demandas de materiais e equipamentos e os investimentos do setor, de uma forma simples e inovadora.

Coloque sua empresa em evidência! Cadastre-a e tenha acesso **gratuito** ao Portal. Conheça a demanda dos seus produtos no setor de P&G, amplie sua visibilidade na cadeia de suprimentos e aumente sua interação com outros fornecedores.

Confira algumas facilidades do Portal:

- **Demanda de materiais e equipamentos:** Conheça a demanda nacional dos seus produtos no setor de P&G.
- **Busca por fornecedores e compradores:** Visualize quem vende o que você compra e quem compra o que você vende.
- **Maior visibilidade:** Veja e seja visto por centenas de empresas da Cadeia de Suprimentos do Setor de P&G.
- **Cadastro fácil e gratuito:** Cadastre sua empresa de forma simples e consulte todos os serviços gratuitamente.



Ministério de Minas e Energia

